

Shaft Diameter d_1	Bearing Housing Designation	h	a	b	c	m		n	w	L	Bolts (No. req.(d.))	Bearing Designation	
						Max	Min						
mm	mm	mm	mm	mm	mm	mm	mm	mm	mm	mm	Inch.		
19.05	SAF 505	38.1	165.1	44.4	17.5	139.7	117.5	----	74.6	73.0	(2)-1/2	----	1205K
23.81	SAF 506	44.4	190.5	50.8	17.5	155.6	133.4	----	85.7	82.6	(2)-1/2	----	1206K
30.16	SAF 507	50.8	190.5	50.8	20.6	155.6	142.9	----	96.8	82.6	(2)-1/2	----	1207K
36.51	SAF 509	57.2	209.6	60.3	20.6	177.8	158.8	----	111.1	92.1	(2)-1/2	22209CCK/W33	1209K
42.86	SAF 510	63.5	209.6	60.3	23.8	177.8	165.1	----	120.6	92.1	(2)-1/2	22210CCK/W33	1210K
49.21	SAF 511	69.8	244.5	69.8	23.8	200.0	187.3	----	133.4	98.4	(2)-5/8	22211CCK/W33	1211K
55.56	SAF 513	76.2	279.4	79.4	25.4	241.3	206.4	50.8	150.8	114.3	(2)-5/8,(4)-1/2	22213CCK/W33	1213K
61.91	SAF 515	82.6	285.8	79.4	28.6	244.5	219.1	47.6	161.9	120.6	(2)-5/8,(4)-1/2	22215CCK/W33	1215K
68.26	SAF 516	88.9	330.2	88.9	30.2	279.4	244.5	54.0	174.6	123.8	(2)-3/4,(4)-5/8	22216CCK/W33	1216K
74.61	SAF 517	95.2	330.2	88.9	31.8	279.4	250.8	54.0	185.7	127.0	(2)-3/4,(4)-5/8	22217CCK/W33	1217K
80.96	SAF 518	101.6	349.2	98.4	41.3	295.3	263.5	54.0	196.8	146.0	(2)-3/4,(4)-5/8	22218CCK/W33	
87.31	SAF 520	114.3	387.4	111.1	44.4	333.4	295.3	60.3	222.2	155.6	(2)-7/8,(4)-3/4	22220CCK/W33	
100.01	SAF 522	125.4	419.1	120.6	50.8	368.3	320.7	69.8	244.5	165.1	(4)-3/4	22222CCK/W33	
106.36	SAF 524	133.4	419.1	120.6	54.0	368.3	336.6	69.8	260.4	187.3	(4)-3/4	22224CCK/W33	
112.71	SAF 526	152.4	466.7	130.2	60.3	406.4	371.5	82.6	292.1	203.2	(4)-7/8	22226CCK/W33	
125.41	SAF 528	152.4	511.2	149.2	60.3	435.0	406.4	85.7	298.4	193.7	(4)-1	22228CCK/W33	
131.76	SAF 530	160.3	539.8	158.8	63.5	463.6	431.8	95.2	317.5	212.7	(4)-1	22230CCK/W33	
138.11	SAF 532	169.9	558.8	158.8	66.7	489.0	441.3	95.2	338.1	222.2	(4)-1	22232CCK/W331	
150.81	SAF 534	179.4	628.6	171.4	69.8	549.3	492.1	108.0	360.4	244.5	(4)-1	22234CCK/W331	
163.51	SAF 536	190.5	679.4	181.0	76.2	600.1	530.2	117.5	377.8	254.0	(4)-1	22236CCK/W331	
176.21	SAF 538	200.0	711.2	190.5	79.4	619.1	549.3	114.3	398.5	273.0	(4)-1, 1/4	22238CCK/W33	
182.56	SAF 540	209.6	749.3	203.2	85.7	635.0	571.5	127.0	419.1	285.8	(4)-1, 1/4	22240CCK/W33	
201.61	SAF 544	241.3	831.8	222.2	95.2	708.0	628.6	133.4	473.1	304.8	(4)-1, 1/2	22244CCK/W33	

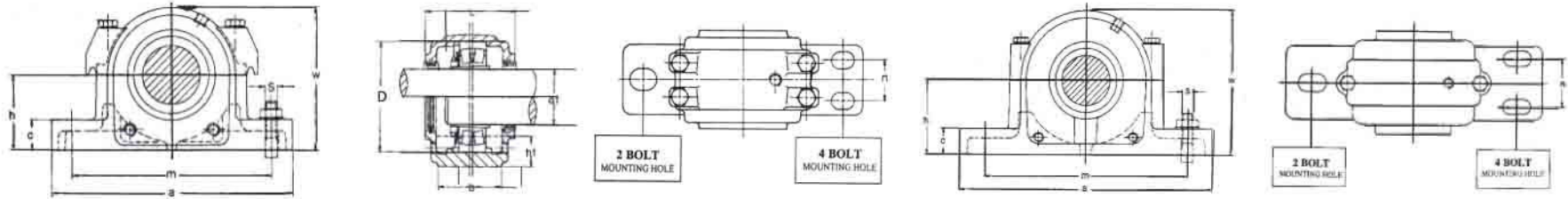

Shaft (1) Diameter d_1	Pillow Block housing designation	h	a	b	c	m		n	w	L	Bolts (No. req.(d.) Inch.	Bearing Designation mm	Bearing Designation mm
						Max	Min						
mm	mm	mm	mm	mm	mm	mm	mm	mm	mm	mm	Inch.	mm	mm
36.51	SAF 609	69.8	244.5	69.8	25.4	200.0	187.3	----	134.9	108.0	(2)-5/8	22309CCK/W33	1309K
42.86	SAF 610	76.2	269.9	69.8	28.6	228.6	196.8	----	147.6	117.5	(2)-5/8	22310CCK/W33	1310K
49.21	SAF 611	82.6	279.4	79.4	30.2	241.3	206.4	50.8	157.2	123.8	(2)-5/8, (4)-1/2	22311CCK/W33	1311K
55.56	SAF 613	88.9	330.2	88.9	31.8	279.7	244.5	54.0	176.2	136.5	(2)-3/4, (4)-5/8	22313CCK/W33	1313K
61.90	SAF 615	101.6	349.2	98.4	41.3	295.3	263.5	54.0	196.8	158.8	(2)-3/4, (4)-5/8	22315CCK/W33	1315K
68.26	SAF 616	108.0	362.0	98.4	44.4	320.7	269.9	54.0	209.6	165.1	(2)-3/4, (4)-5/8	22316CCK/W33	1316K
74.61	SAF 617	114.3	387.4	111.1	44.4	333.4	295.3	60.3	222.2	171.4	(2)-7/8, (4)-3/4	22317CCK/W33	1317K
80.96	SAF 618	120.6	393.7	111.1	50.8	342.9	304.8	57.2	235.0	174.6	(4)-3/4	22318CCK/W33	1318K
87.31	SAF 620	133.4	419.1	120.6	54.0	368.3	336.6	69.8	260.4	187.3	(4)-3/4	22320CCK/W33	1320K
100.01	SAF 622	152.4	466.7	130.2	60.3	406.4	371.5	82.6	292.1	203.2	(4)-7/8	22322CCK/W33	1322K
106.36	SAF 624	160.3	539.8	158.8	63.5	463.6	431.8	95.2	317.5	212.7	(4)-1	22324CCK/W33	
112.71	SAF 626	169.9	558.8	158.8	66.7	489.0	441.3	95.2	338.1	222.2	(4)-1	22326CCK/W33	
125.41	SAF 628	179.4	628.6	171.4	69.8	549.3	492.1	108.0	360.4	244.5	(4)-1	22328CCK/W33	
131.76	SAF 630	190.5	679.4	181.0	76.2	600.1	530.2	117.5	377.8	247.6	(4)-1	22330CCK/W33	
138.11	SAF 632	200.0	711.2	190.5	79.4	619.1	549.3	114.3	398.5	273.0	(4)-1, 1/4	22332CCK/W33	
150.81	SAF 634	209.6	749.3	203.2	85.7	635.0	571.5	127.0	419.1	285.8	(4)-1, 1/4	22334CCK/W33	
176.21	SAF 638	241.3	831.8	222.2	95.2	708.0	628.6	133.4	473.1	304.8	(4)-1, 1/2	22338CCK/W33	

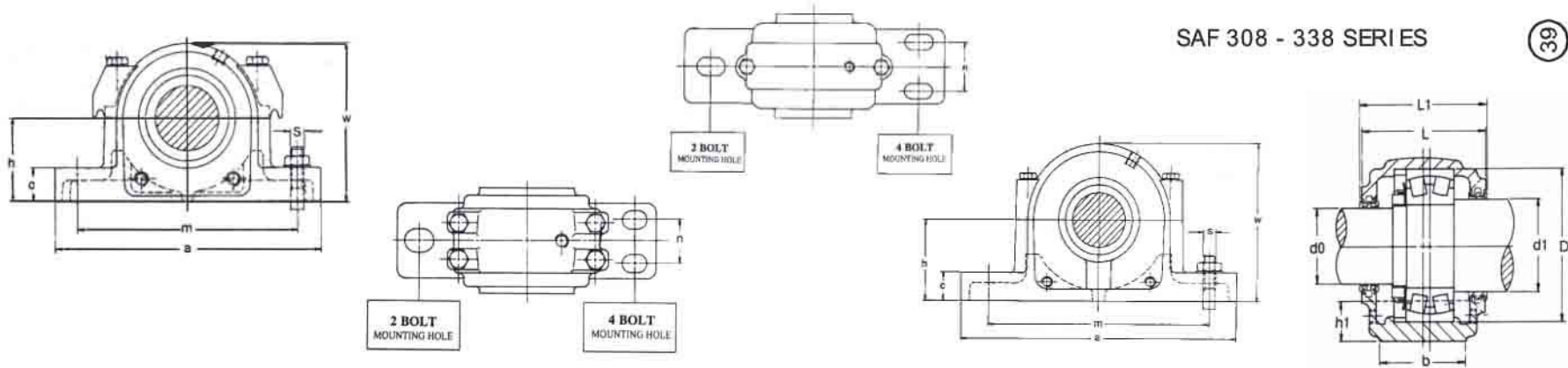

Shaft (1) Diameter		Pillow Block housing designation	h	a	b	c	m		n	w	L	Bolts (No.) req.(d.)	Bearing Designation	
d ₁	d ₂						Max	Min						
mm	mm	mm	mm	mm	mm	mm	mm	mm	mm	mm	Inch.			
49.21	36.51	SAF 308	63.5	209.6	60.3	25.4	177.8	165.1	----	122.2	101.6	(2)-1/2	1308	22308CC/W33
53.98	42.86	SAF 309	69.8	244.5	69.8	25.4	200.0	187.3	----	134.9	108.0	(2)-5/8	1309	22309CC/W33
60.32	47.62	SAF 310	76.2	269.9	69.8	28.6	228.6	196.8	----	147.6	117.5	(2)-5/8	1310	22310CC/W33
65.09	52.39	SAF 311	82.6	279.4	79.4	30.2	241.3	206.4	50.8	157.2	127.0	(2)-5/8, (4)-1/2	1311	22311CC/W33
73.02	57.15	SAF 312	82.6	285.8	79.4	30.2	244.5	219.1	47.6	161.9	133.4	(2)-5/8, (4)-1/2	1312	22312CC/W33
77.79	61.91	SAF 313	88.9	330.2	88.9	31.8	279.4	244.5	54.0	176.2	136.5	(2)-3/4, (4)-5/8	1313	22313CC/W33
82.55	66.68	SAF 314	95.2	330.2	88.9	31.8	279.4	250.8	54.0	187.3	136.5	(2)-3/4, (4)-5/8	1314	22314CC/W33
87.31	71.44	SAF 315	101.6	349.2	98.4	33.3	295.3	263.5	54.0	198.4	158.8	(2)-3/4, (4)-5/8	1315	22315CC/W33
92.08	76.20	SAF 316	108.0	362.2	98.4	33.3	320.7	269.9	54.0	209.6	165.1	(2)-3/4, (4)-5/8	1316	22316CC/W33
100.01	80.96	SAF 317	114.3	387.4	111.1	44.4	333.4	295.3	60.3	222.2	171.4	(2)-7/8, (4)-3/4	1317	22317CC/W33
104.78	85.72	SAF 318	120.6	393.7	111.1	50.8	342.9	304.8	57.2	233.4	174.6	(4)-3/4	1318	22318CC/W33
114.30	96.84	SAF 320	133.4	419.1	120.6	54.0	368.3	336.6	69.8	260.4	187.3	(4)-3/4	1320	22320CC/W33
123.82	106.36	SAF 322	152.4	466.7	130.2	60.3	406.4	371.5	82.6	292.1	203.2	(4)-7/8	1322	22322CC/W33
134.94	115.89	SAF 324	160.3	539.8	158.8	63.5	463.6	431.8	95.2	317.5	212.7	(4)-1		22324CC/W33
149.22	125.41	SAF 326	169.9	558.8	158.8	66.7	489.0	441.3	95.2	338.1	222.2	(4)-1		22326CC/W33
158.75	134.94	SAF 328	179.4	628.6	171.4	69.8	549.3	492.1	108.0	360.4	238.1	(4)-1		22328CC/W33
168.28	146.05	SAF 330	190.5	679.4	181.0	76.2	600.1	530.2	117.5	377.8	247.6	(4)-1		22330CC/W33
177.80	153.99	SAF 332	200.0	711.2	190.5	79.4	619.1	549.3	114.3	398.5	273.0	(4)-1, 1/4		22332CC/W33
188.91	163.51	SAF 334	209.6	749.3	203.2	85.7	635.0	571.5	127.0	419.1	285.8	(4)-1, 1/4		22334CC/W33
212.72	184.15	SAF 338	241.3	831.8	222.2	95.2	708.0	628.6	133.4	473.1	304.8	(4)-1, 1/2		22338CC/W33

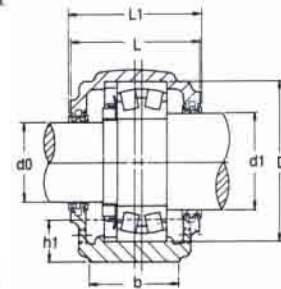
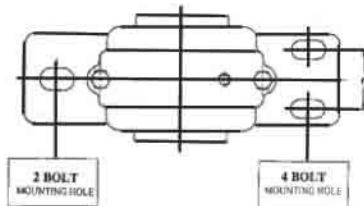
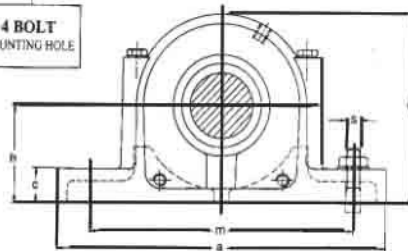
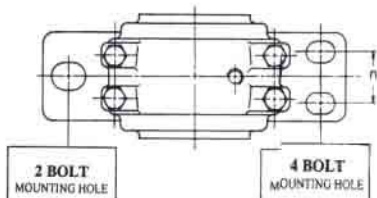
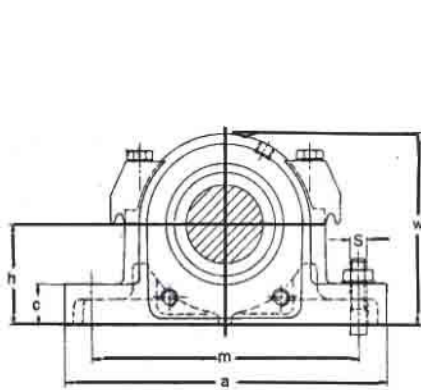

SAF216-244 SERIES

Shaft (1) Diameter		Pillow Block housing designation	Bearing (2) Designation	m							Bolts (No.) req.(d.)		
d ₁	d ₂			h	a	b	c	Max	Min	n		w	L
mm		mm	mm	mm	mm	mm	mm	mm	mm	mm	mm		
92.08	76.2	SAF 216	22216CC/W33	88.9	330.2	88.9	31.8	279.4	244.5	54.0	176.2	136.5	(2)-3/4,(4)-5/8
100.01	80.96	SAF 217	22217CC/W33	95.2	330.2	88.9	31.8	279.4	250.8	54.0	187.3	127.0	(2)-3/4,(4)-5/8
104.78	85.72	SAF 218	22218CC/W33	101.6	349.2	98.4	41.3	295.3	263.5	54.0	196.8	146.0	(2)-3/4,(4)-5/8
114.30	96.84	SAF 220	22220CC/W33	114.3	387.4	111.1	44.4	333.4	295.3	60.3	222.2	155.6	(2)-7/8,(4)-3/4
123.82	106.36	SAF 222	22222CC/W33	125.4	419.1	120.6	50.8	368.3	320.7	69.8	244.5	165.1	(4)-3/4
134.94	115.89	SAF 224	22224CC/W33	133.4	419.1	120.6	54.0	368.3	336.6	69.8	260.4	187.3	(4)-3/4
149.22	125.41	SAF 226	22226CC/W33	152.4	466.7	130.2	60.3	406.4	371.5	82.6	292.1	203.2	(4)-7/8
158.75	134.95	SAF 228	22228CC/W33	152.4	511.2	149.2	60.3	435.0	406.4	85.7	298.4	193.7	(4)-1
168.28	146.05	SAF 230	22230CC/W33	160.3	539.8	158.8	63.5	463.6	431.8	95.2	317.5	212.7	(4)-1
177.8	153.99	SAF 232	22232CC/W33	169.9	558.8	158.8	66.7	489.0	441.3	95.2	338.1	222.2	(4)-1
188.91	163.51	SAF 234	22234CC/W33	179.4	628.6	171.4	69.8	549.3	492.1	108.0	360.4	244.5	(4)-1
198.44	174.62	SAF 236	22236CC/W33	190.5	679.4	181.0	76.2	600.1	530.2	117.5	377.8	254.0	(4)-1
212.72	184.15	SAF 238	22238CC/W33	200.0	711.2	190.5	79.4	619.1	549.3	114.3	398.5	273.0	(4)-1, 1/4
222.25	193.68	SAF 240	22240CC/W33	209.6	749.3	203.2	85.7	635.0	571.5	127.0	419.0	285.8	(4)-1, 1/4
242.89	211.14	SAF 244	22244CC/W33	241.3	831.8	222.2	95.2	708.0	628.6	133.4	473.0	304.8	(4)-1, 1/2